

indicação do tipo de fixação à parede | indicación del tipo de fijación a la pared  
 indication of type wall fixation | indication du type de fixation sur le mur

sanindusa®

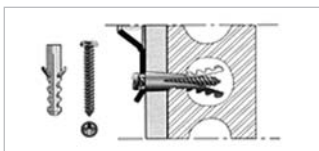

**CARACTERÍSTICAS**  
 Bucha em nylon com alheta anti-rotacional  
**APLICAÇÕES**  
 Indicado para materiais de fixação universal  
**UTILIZAR BROCA Ø 8**

**CHARACTERISTICS**  
 Nylon nog with anti-rotation wings  
**APPLICATIONS**  
 It is recommended for the main building materials  
**(UNIVERSAL FIXING)**  
**USE Ø 8 NOGS**

**CARACTERÍSTICAS**  
 Taco de nylon con aleta antirotacion  
**APLICACIONES**  
 Indicado para materiales de fijación universal  
**UTILIZAR BROCA Ø 8**

**CARACTÉRISTIQUES**  
 Cheville en nylon avec rebord anti-rotation  
**APPLICATIONS**  
 Indiqué pour matériaux de fixation universelle  
**UTILISER UN FORET Ø 8**

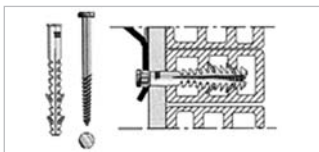

**CARACTERÍSTICAS**  
 Bucha em nylon com corpo longo com duplo enclavamento  
**APLICAÇÕES**  
 Indicado para materiais perfurados e aligeirados  
**UTILIZAR BROCA Ø 8**

**CHARACTERISTICS**  
 Nylon nog with extended and double winged body  
**APPLICATIONS**  
 It is recommended for half-full and lightened materials  
**USE Ø 8 NOGS**

**CARACTERÍSTICAS**  
 Taco de nylon con cuerpo largo con doble engarcho  
**APLICACIONES**  
 Indicado para materiales perfurados y ligeros  
**UTILIZAR BROCA Ø 8**

**CARACTÉRISTIQUES**  
 Cheville longue en nylon avec double enclavement  
**APPLICATIONS**  
 Indiqué pour matériaux perforés et allégés  
**UTILISER UN FORET Ø 8**

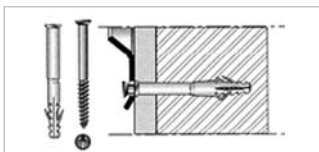

**CARACTERÍSTICAS**  
 Bucha em nylon com corpo longo  
**APLICAÇÕES**  
 Indicado para paredes maciças  
**UTILIZAR BROCA Ø 8**

**CHARACTERISTICS**  
 Nylon nog with extended body  
**APPLICATIONS**  
 It is recommended for compact brickworks  
**USE Ø 8 NOGS**

**CARACTERÍSTICAS**  
 Taco de nylon con cuerpo largo  
**APLICACIONES**  
 Indicado para paredes macizas  
**UTILIZAR BROCA Ø 8**

**CARACTÉRISTIQUES**  
 Cheville longue en nylon  
**APPLICATIONS**  
 Indiqué pour murs épais  
**UTILISER UN FORET Ø 8**

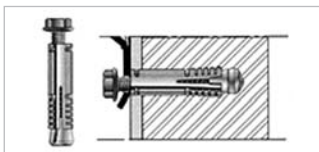

**CARACTERÍSTICAS**  
 Bucha em aço  
**APLICAÇÕES**  
 Indicado para betão e paredes maciças  
**UTILIZAR BROCA Ø 12- M6**

**CHARACTERISTICS**  
 Steel single-shielded nog  
**APPLICATIONS**  
 It is recommended for concrete and full bricks  
**USE Ø 12 – M6 NOGS**

**CARACTERÍSTICAS**  
 Taco de acero  
**APLICACIONES**  
 Indicado para betão e paredes macizas  
**UTILIZAR BROCA Ø 12- M6**

**CARACTÉRISTIQUES**  
 Cheville en acier  
**APPLICATIONS**  
 Indiqué pour béton et murs épais  
**UTILISER UN FORET Ø 12 – M6**

Os acessórios SANINDUSA | UNISAN foram criados e desenhados para suportar facilmente o peso de uma pessoa. No entanto, de modo a não comprometer a eficácia e funcionalidade dos nossos acessórios, é necessário prestar particular atenção à escolha do tipo de fixação, de acordo com a parede onde este vai fixar.

**Sendo impossível para a SANINDUSA | UNISAN inspeccionar as condições da parede, bem como os procedimentos efectuados no decorrer da instalação, declinamos qualquer responsabilidade por uma instalação defeituosa.**

Los accesorios SANINDUSA | UNISAN fueron creados y desarrollados para soportar facilmente el peso de una persona. Por lo tanto, para no comprometer la eficacia y funcionalidad de nuestros accesorios es necesario prestar particular atención al elegir el tipo de fijación de acuerdo con la pared.

**Siendo imposible por SANINDUSA | UNISAN inspeccionar las condiciones de las paredes, tanto como los procedimientos utilizados para decorar la instalación, declinamos cualquier responsabilidad por una instalación defectuosa.**

In order not to seriously compromise the functionality and the efficacy of SANINDUSA | UNISAN accessories, designed and created to easily support one person's weight, it is however necessary to pay particular attention to the choice of the type of fixing, according to the wall on which we are going to work. Therefore, granted that the nog must be housed in a strong wall, we introduce here after some examples of installation accompanied by simple suggestions for the choice of the suitable nog.

**Being impossible for SANINDUSA | UNISAN saniline to inspect the conditions of the walls and the procedures which were followed during the mounting, we refuse any responsibility for defective installation.**

Les accessoires SANINDUSA | UNISAN ont été créés et dessinés pour supporter aisément le poids d'une personne. Toutefois, de façon à ne pas compromettre l'efficacité et le caractère fonctionnel de nos accessoires, il est nécessaire de prêter une attention particulière au choix du type de fixation, de façon à ce que celui-ci soit en accord avec les caractéristiques du mur.

**SANINDUSA | UNISAN étant dans l'impossibilité d'inspecter les conditions du mur, ainsi que les procédures effectués pendant l'installation, nous déclinons toute responsabilité en cas d'installation défectueuse.**

instruções de montagem

instrucciones de montaje

mounting instructions

notice de montage

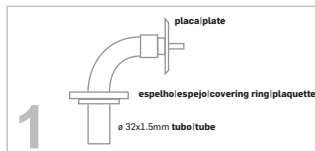

Inserir os espelhos na barra de apoio e fixar a extremidade da placa para a fixação à parede (com os parafusos incluídos na embalagem).

Colocar los espejos en la barra de apoyo y fijar las extremidades de la placa para la fijación a la pared.

Insert the covering rings in the hand bar and fix the ends the plate for the fixing to the wall (with the screws included in the packaging).

Insérer les plaquettes sur la bar d'appui et fixer l'extrémité à la plaque pour la fixation au mur (avec les vis inclus dans l'emballage).

Inserir os espelhos no espaçador (incluídos na embalagem de acordo com o artigo) e fixar este último às placas com a respectiva bucha.

Colocar los espejos con espaciador (incluidos en el embalaje) y fijar este ultimo con las placas en el respectivo taco.

Insert the rings in the spacers (included in the packaging according to the article) and fix the latter with the plates to the related bushings.

Insérer les plaquettes dans l'espaceur (inclus dans l'emballage suivant article) et fixer ce dernier aux plaques avec les chevilles respectives.

Encostar a barra de apoio à parede, nivelar e marcar a posição dos furos.

Encostar la barra de apoio à la pared, nivelar y marcar la posición de los agujeros.

Put the hand bar near to the wall and – checking it is planar – mark the position of the holes

Placer la barre d'appui contre le mur, nivelar et marquer la position des trous.

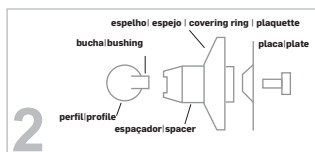

Perfurar de acordo com as marcas assinaladas e introduzir as buchas.

Perforar de acuerdo con las marcas asignadas e introducir los tacos.

Drill precisely the hole according to the markings and insert the suitable nogs.

Percer en respectant les points faites au préalable et introduire les chevilles.

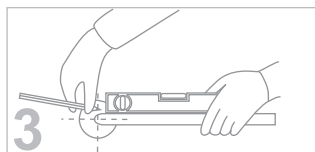

Apertar bem os parafusos de fixação.

Apretar los tornillos de fijación.

Screw tightly the fixing screws.

Bien serrer les vis de fixation.

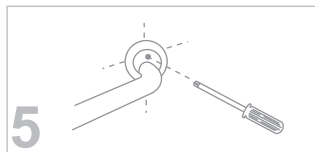
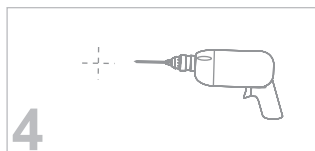

Primir e encaixar os espelhos na placa.

Encajar la espejos e la placa.

Place the rings and push to fit them to the plates

Comprimer et placer les plaquettes sur la plaque.

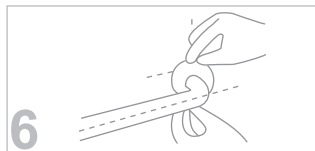

**ATENÇÃO.** Não são fornecidos os parafusos de fixação bem como as buchas, nestes produtos. Para não comprometer a eficácia do tratamento anti corrosão dos nossos artigos, aconselhamos a não efectuar qualquer tipo de corte no produto.

**ATENCIÓN.** No se incluyen los juegos de fijación. Para no comprometer la eficacia del tratamiento anticorrosión de nuestros productos aconsejamos no hacer ningún corte.

**ATTENTION.** The nogs and screws are not supplied with our products. In order not to compromise the efficacy of the anticorrosive treatments our aids were subject to, we suggest not to cut the profiles.

**ATTENTION.** Les vis de fixation et les chevilles ne sont pas inclus à l'emballage. Pour ne pas compromettre l'efficacité du traitement anti-corrosion de nos articles, nous conseillons de n'effectuer aucun type de coupure sur ce produit.

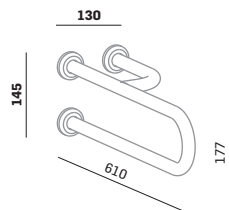
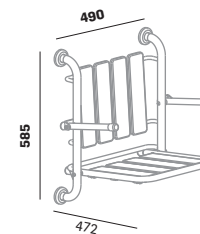
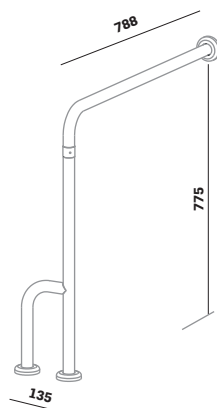
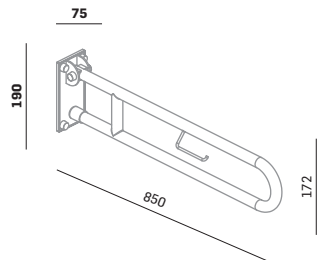
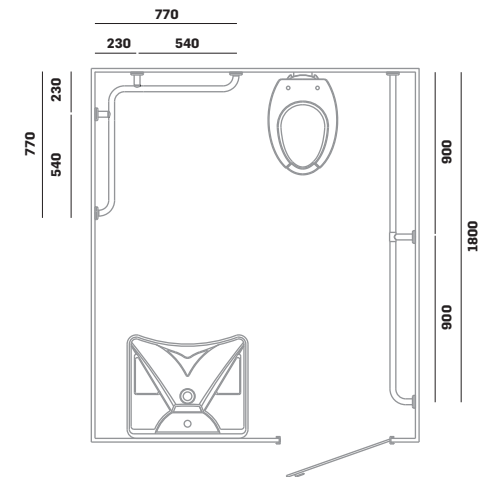
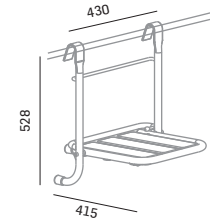
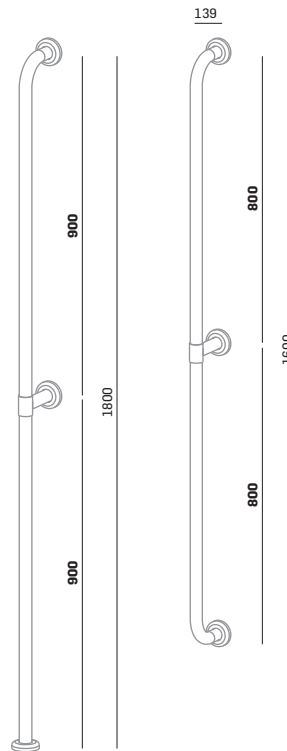
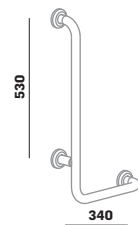
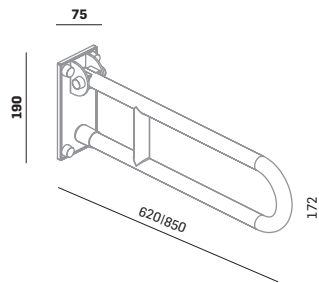
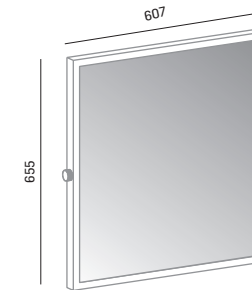
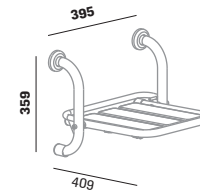
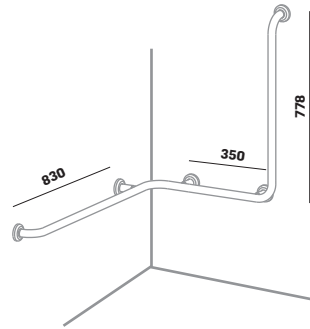
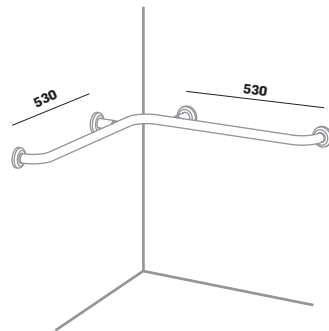
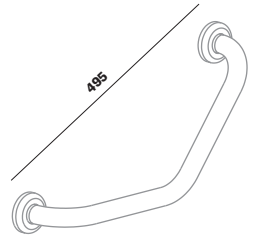

Todos os acessórios de segurança horizontais devem ser montados segundo os códigos e regulamentos aplicáveis. | Todos los accesorios de seguridad deben ser montados según los códigos y reglamentos aplicables. | All horizontal safety accessories must be installed in accordance with applicable codes and regulations. | Tous les accessoires horizontaux de sûreté doivent être installée selon les codes et règlements applicables.

As cotas são meramente indicativas para uma montagem perfeita siga o passo #3 da instrução de montagem. | Las cotas son meramente indicativas para un montaje perfecta siga el paso #3 de la instrucion de montaje. | The measures reported in this instruction sheet are to be considered indicative; in order to obtain a perfect marking please act as indicated in this step. | Les cotes indiquées sont indicatives pour un montage parfait veuillez suivre le point #3 de la notice de montage.

